

Bill of Materials

Part	Material
1	Chamber
2	Cover
3	Glass
4	Gasket
4	Shield
5	Cushion
6	Bolt
7	Washer
8	Nut
9	Nipples & Center Tube

Notes

Dimensions

C	
D	

Steam-Trac ST-1000



2-Section



The New Standard of Level

Customer:		Drawing No:	
Cust. Ref:		Serial No:	
Factory Ref:		Drawn By:	EB
Date:		Checked By:	
		Certified By:	

Model	Dim "A"	Dim "B"
ST-1000-72	10.250	
ST-1000-82	11.875	
ST-1000-92	12.625	
Dimensions in Inches		

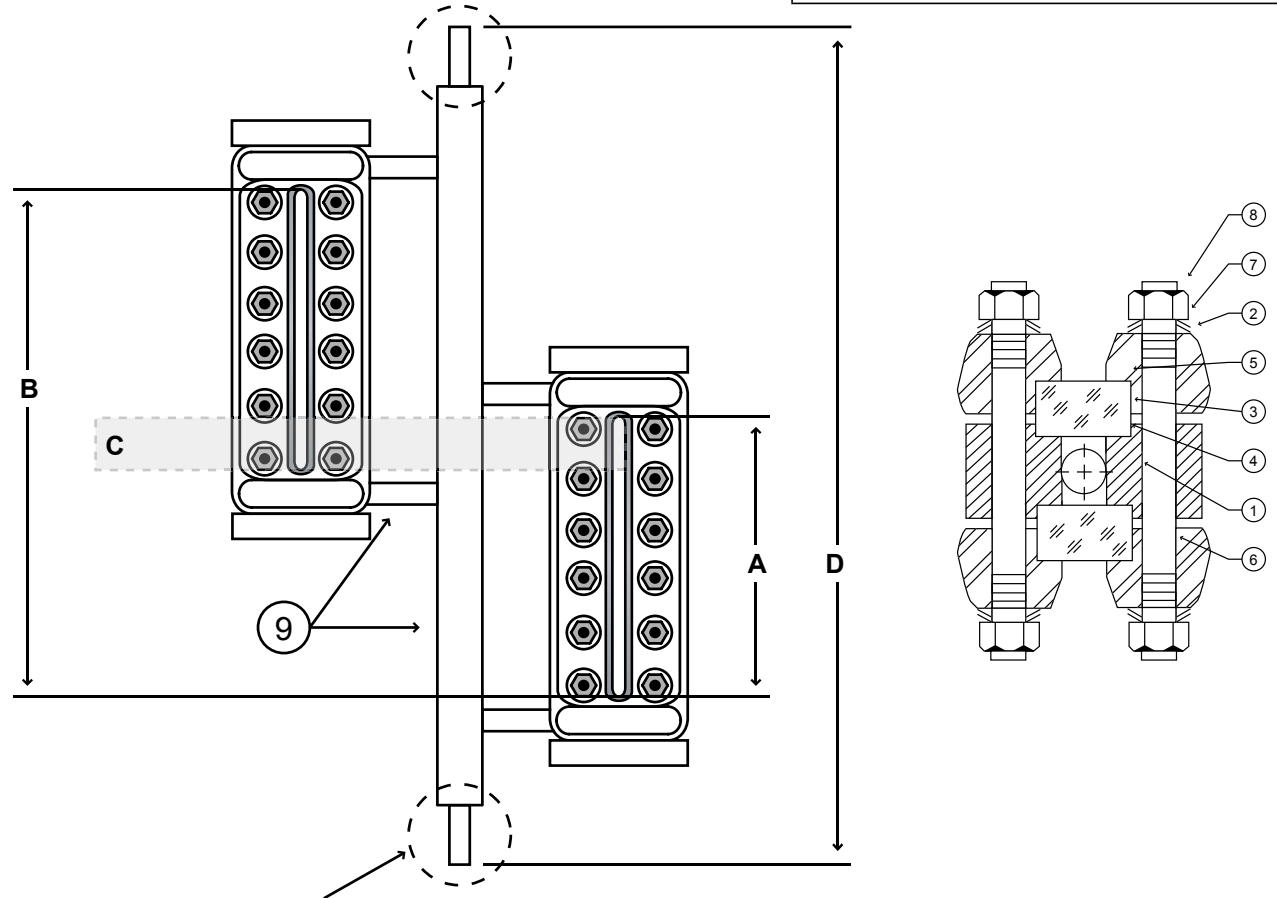

Gage Connection Options

