

Bill of Materials

Part	Material
1 Chamber	
2 End Caps	
3 Nozzle	
4 Flange	
5 Probe Covers	
6 Probe	
7 Fitting	

Notes

Dimensions (inches)

A	First Probe:
B	Visible Range:
C	Conn. Centers:
D	Overall Length:

Level-Trac Model 502
Water Column



With 14
Type 802 Probes



Customer:		Drawing No:	
Cust. Ref:		Serial No:	
Factory Ref:		Drawn By:	EB
Date:		Checked By:	
		Certified By:	

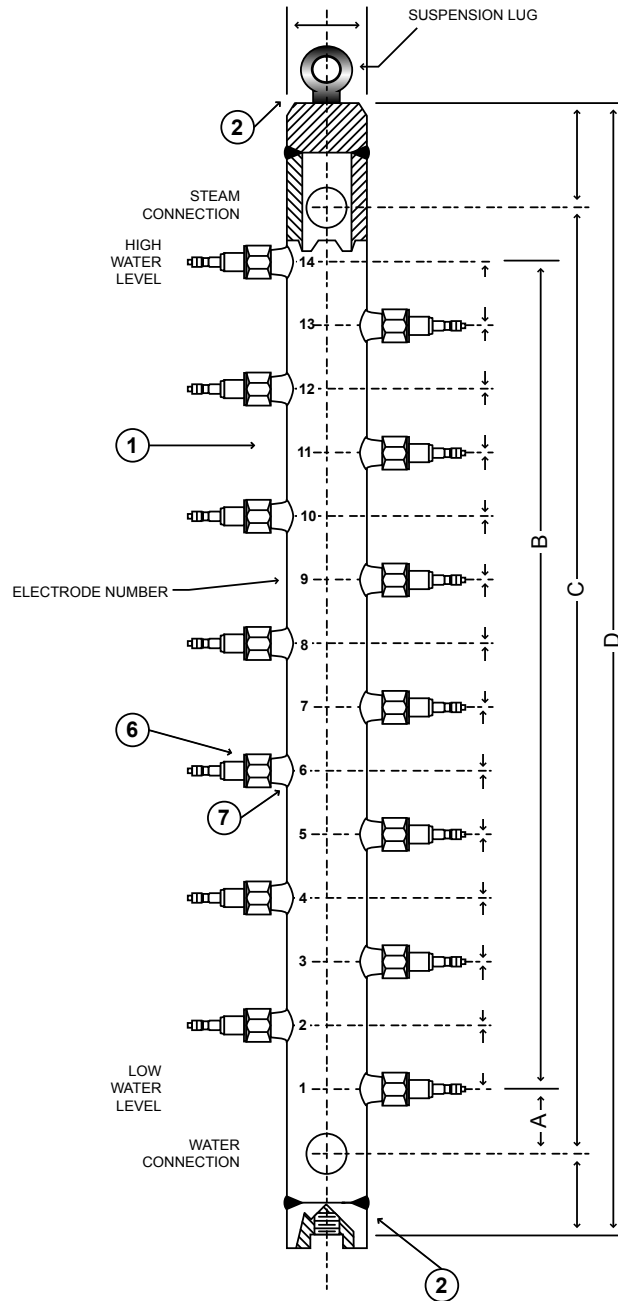

Plan View

